

OPERATION MANUAL

RESISTOMAT® 2x11 PROFINET Manual

© 2022 burster
präzisionsmesstechnik gmbh & co kg
Alle Rechte vorbehalten

Manufacturer:
burster
präzisionsmesstechnik gmbh & co kg
Talstraße 1 - 5 Postfach 1432
D-76593 Gernsbach D-76593 Gernsbach
Germany Germany

Valid from: **11.04.2022**
Applies to: **Resistomat 2x11 VXX03**

Tel.: (+49) 07224 645-0
Fax.: (+49) 07224 645-88
E-Mail: info@burster.com
www.burster.com

4230-BA2311PROFINETEN-5999-041526

Exclusion of warranty liability for operating manuals

All information in the present documentation was prepared and compiled with great care and reproduced subject to effective control measures. No warranty is provided for freedom from errors. We reserve the right to make technical changes. The present information as well as the corresponding technical data can change without notice. Reproduction of any part of this documentation or its processing or revision using electronic systems is prohibited without the manufacturer's prior written approval.

Components, devices and measured value sensors made by burster praezisionsmesstechnik (hereinafter referred to as "product") are the results of targeted development and meticulous research. As of the date of delivery, burster provides a warranty for the proper condition and functioning of these products covering material and production defects for the period specified in the warranty document accompanying the product. However, burster excludes guarantee or warranty obligations as well as any liability beyond that for consequential damages caused by improper use of the product, in particular the implied warranty of success in the market as well as the suitability of the product for a particular purpose. Furthermore, burster assumes no liability for direct, indirect or incidental damages as well as consequential or other damages arising from the provision and use of the present documentation.



Certificate

PROFIBUS Nutzerorganisation e.V. grants to

burster präzisionsmesstechnik gmbh & co kg

Talstr. 1-5, 76593 Gernsbach, Germany

the Certificate No: **Z13185** for the PROFINET IO Device:

Model Name: 2311-V0001
 Revision: SW/FW: V21.1.0; HW: V1
 GSD: GSDML-V2.35-BURSTER-RESISTOMAT-2311-20211019.xml
 Identnumber: 0x01CE; 0x0003
 DAP: DIM 24, 0x00000001

This certificate confirms that the product has successfully passed the certification tests with the following PROFINET scope:

<input checked="" type="checkbox"/>	PNIO_Version	V2.35
<input checked="" type="checkbox"/>	Conformance Class	B
<input checked="" type="checkbox"/>	Optional Features	Legacy, MRP
<input checked="" type="checkbox"/>	Netload Class	III
<input checked="" type="checkbox"/>	PNIO_Tester_Version	V2.41.0.2 with annex Spirta
<input checked="" type="checkbox"/>	Tester	an testlabs, Prague, Czech Republic; PN 021-23

This certificate is granted according to the document:

“Framework for testing and certification of PROFIBUS and PROFINET products”.

For all products that are placed in circulation by **October 27, 2024** the certificate is valid for life.

Karlsruhe, December01, 2021

(Official in Charge)

Board of PROFIBUS Nutzerorganisation e. V.

(Karsten Schneider)



(Dr. Jörg Hähnliche)

Table of contents

1	For your safety	6
1.1	Symbols used in the instruction manual.....	6
1.1.1	Signal words	6
1.1.2	Pictograms	6
1.2	Symbols and precautionary statements on the instrument.....	7
1.2.1	Conventions used in the instruction manual.....	7
1.3	Abbreviations.....	7
2	Introduction	8
2.1	General safety instructions.....	8
2.2	Intended use.....	9
3	Technical data	10
3.1	Supported PROFINET-functions	10
3.2	Model 2x11 device data	10
3.3	Electrical safety	10
3.4	Electromagnetic compatibility.....	11
3.4.1	Interference immunity	11
3.4.2	Emitted interference.....	11
3.5	Notes on CE labeling.....	11
4	Installation	12
4.1	Connection of fieldbus lines	12
4.2	Meaning of LED states	12
4.3	Port-Identification	12
4.4	Configuration of a PROFINET network.....	13
4.5	Configuration menu in RESISTOMAT® 2x11	14
5	PROFINET	17
5.1	General information on PROFINET data transfer	17
5.2	GSDML file	17
5.3	Data conversion	18
5.3.1	Description of the data formats in this manual	18
5.3.2	Handling problems that arise when reading floating-point numbers	18
6	PROFINET data protocol	19
6.1	PLC inputs – Transfer from controller to device.....	19
6.1.1	PLC inputs byte 1.....	19
6.1.2	PLC inputs byte 2.....	19
6.1.3	PLC inputs byte 3.....	20
6.1.4	PLC inputs byte 4.....	20
6.2	PLC outputs – Transfer from device to controller	21
6.2.1	PLC outputs byte 1	21
6.2.2	PLC outputs byte 2	21

6.2.3	PLC outputs byte 3	22
6.2.4	PLC outputs byte 4	22
7	Acyclic PROFINET services	23
7.1	Instrument configuration	23
7.1.1	General settings (Slot 30)	23
7.1.2	Display update and fault indication (Slot 31)	27
7.1.3	Program Selection/Renaming & comparator statistics reset (Slot 32)	28
7.1.4	Channel assignment (Slot 33)	29
7.1.5	Measurement mode (Slot 38)	29
7.1.6	Copy/initialize measurement programs (Slot 39).....	31
7.1.7	USB-Logging (Slot 40).....	31
7.1.8	Data-Logging (Slot 41).....	32
7.1.9	Comparator (Slot 42)	34
7.1.10	Max / Min Values (Slot 43).....	35
7.1.11	PT100 (Slot 44).....	35
7.1.12	Temperature compensation (Slot 45)	36
7.1.13	Scaling of voltage input (Slot 46).....	36
7.1.14	Cooling curve (Slot 47)	37
7.1.15	Current measurement values (Slot 48).....	37
7.1.16	Record errors/events in the logfile (Slot 49)	39
7.1.17	General Purpose (Slots 60-70)	40
7.2	Error Codes	41



1 For your safety

The following symbols on the RESISTOMAT® 2x11 and in this operation manual warn of hazards.

1.1 Symbols used in the instruction manual

1.1.1 Signal words



The following signal words are used in the operation manual according to the specified hazard classification.

	DANGER
High degree of risk: indicates a hazardous situation which, if not avoided, will result in death or serious injury.	
	WARNING
Moderate degree of risk: indicates a hazardous situation which, if not avoided, may result in death or serious injury.	
	CAUTION
Low degree of risk: indicates a hazardous situation which, if not avoided, could result in minor or moderate injury.	
NOTICE	
Property damage to the equipment or the surroundings will result if the hazard is not avoided.	

Hinweis: It is important to heed these safety notices in order to ensure you handle the RESISTOMAT® 2x11 correctly.

Note: Follow the information given in the operation manual.

1.1.2 Pictograms

Symbol	Description
	Warning concerning the use and installation of the device and software.
	Observe the advice for protecting the instrument.

1.2 Symbols and precautionary statements on the instrument

Symbol	Description
	Hazard warning Disconnect the power plug before opening – Follow safety instructions – Professional servicing only
Warning ! To prevent electrical shock do not open device.	Warning of electrical shock hazard Do not open the unit.
To prevent fire replace only with same type and rating of fuse !	Warning of fire hazard Always replace the fuse with a fuse of the same type and rating.

1.2.1 Conventions used in the instruction manual



Designation	Description
[Fx]	Function keys F1 to F3 on the touchscreen display
[Text]	Buttons on the touchscreen display
"Term"	Terms used in the instrument menus



1.3 Abbreviations

Abbreviation	Description
BF	Bus error
GSD	Device description data
GSDML	The GSDML file describes the physical properties of the device.
PI	PROFIBUS and PROFINET International (user organization)

2 Introduction

2.1 General safety instructions

	 DANGER
	<p>Warning concerning installation of the device and software</p> <p>Installation of the device and the interface must be carried out by qualified personnel only. Qualified personnel meets the following requirements:</p> <ul style="list-style-type: none">• You are familiar with the safety designs used in automation engineering, and understand how to deal with them in your capacity as configuration engineer.• You are an operator of automation systems and have been instructed in how to handle the system. You are familiar with the operation of the equipment described in this documentation.• You are a commissioning or service engineer and have successfully completed a training course qualifying you to repair automation systems. In addition, you are authorized to commission, ground and label circuits and equipment in accordance with safety engineering standards. <p>Always observe the current safety and accident prevention regulations when commissioning the equipment. Install automation engineering equipment and installations with sufficient protection against accidental actuation.</p>

	 DANGER
	<p>Warning concerning use of the device</p> <ul style="list-style-type: none">• Take suitable precautions in both the hardware and software to prevent any undefined states of the automation installation in the event of an open circuit.• In installations where major damage to property or even personal injury may be caused by a malfunction, take suitable precautions to establish a safe operating state in the event of a fault. This may be achieved using limit switches, mechanical interlocks etc. for example.• Do not make unauthorized modifications to the device or to the PROFINET interface.• Always observe the current safety and accident prevention regulations when commissioning the equipment. <p>Install automation engineering equipment and installations with sufficient protection against accidental actuation.</p>



NOTICE

- Install the power, signal and sensor cables so as to prevent electromagnetic interference from impairing operation of the equipment.
- Proper transportation, storage, installation and assembly plus careful operation and maintenance are essential for trouble-free and safe operation of the equipment.
- Have non-functional instruments inspected by the manufacturer.

2.2 Intended use

3 Technical data

3.1 Supported PROFINET-functions

- Conformance Classes: A, B
- Shared Device
- Media Redundancy Protocol (MRP)
- Link Layer Discovery Protocol (LLDP)
- I&M Services (I&M0-I&M4)

*Specified according to PROFINET version 2.2

I&M0 identification:

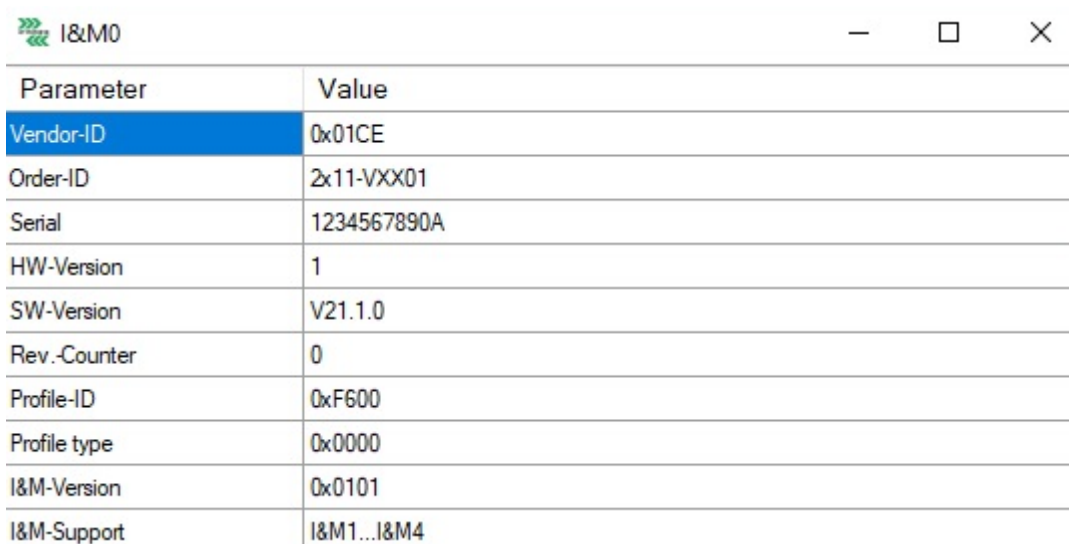

Parameter	Value
Vendor-ID	0x01CE
Order-ID	2x11-VXX01
Serial	1234567890A
HW-Version	1
SW-Version	V21.1.0
Rev.-Counter	0
Profile-ID	0xF600
Profile type	0x0000
I&M-Version	0x0101
I&M-Support	I&M1...I&M4

Diagram 1: I&M0 Identification

Profil-ID: 0xF600 (Generic Device)

You will find further information about PROFINET at www.profibus.com.

3.2 Model 2x11 device data

Bus connector	RJ45
GSD file	GSDML-V2.31-BURSTER-2x11-20210501-155500.xml

3.3 Electrical safety

Reverse voltage protection	Yes
Air clearance/leakage paths	To DIN EN 61010-1:2011
Electrical isolation	Between fieldbus and internal electronics
Withstand voltage	DC 500 V

3.4 Electromagnetic compatibility

3.4.1 Interference immunity

Interference immunity to EN 61326-1:2013

Industrial locations

3.4.2 Emitted interference

Emitted interference to EN 61326-1:2013

Class A

EN 61000-3-2:2014

EN 61000-3-3:2013

3.5 Notes on CE labeling

burster equipment carrying the CE mark meets the requirements of the EU directives and the harmonized European standards (EN) cited therein.

The EU declarations of conformity are available to the relevant authorities as specified in the directives. A copy of the declaration of conformity is included in the relevant equipment documentation.

4 Installation

Please note that you can download various documents such as installation guidelines and specifications about PROFINET at PI: www.profibus.com.

4.1 Connection of fieldbus lines

burster devices with a PROFINET option have two **RJ 45** connectors for the fieldbus connection.

4.2 Meaning of LED states



LED	Blinking	On
ACT	Data transmission	x
LNK / LA	PROFINET device localization	Ethernet line monitoring
SF	x	System error
US2	x	Sensor supply voltage
BF	Bus error	
BOOT	DCP signal confirmation	x
US1	x	Supply voltage

4.3 Port-Identification

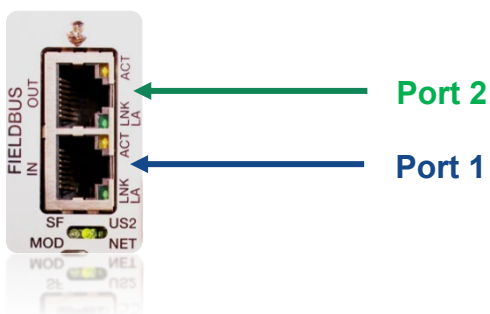

4.4 Configuration of a PROFINET network

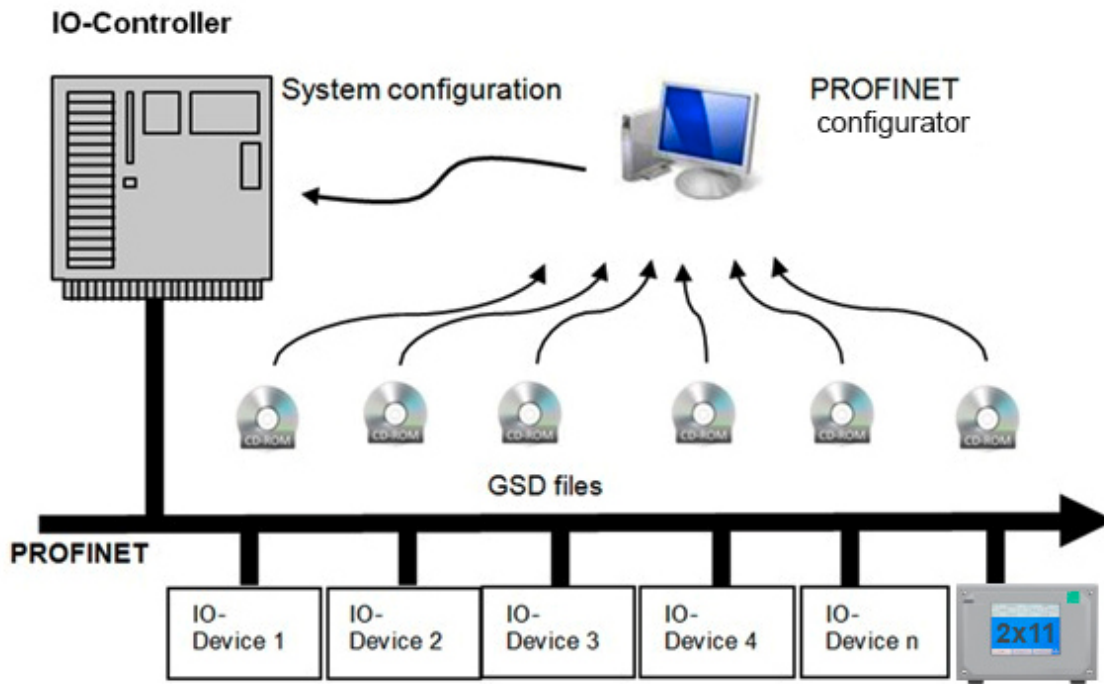

Diagram 2: Configuration of a PROFINET network

4.5 Configuration menu in RESISTOMAT® 2x11

To access the menu

Start in measurement mode. After power on the measurement mode is always set. The display will look differently dependent on your settings or your last measurements.

You can go to "Configuration Main Menu" in measurement mode by pressing the **settings** button.



This is how it works

1. In measurement mode, press the **settings** button (gear wheel symbol)

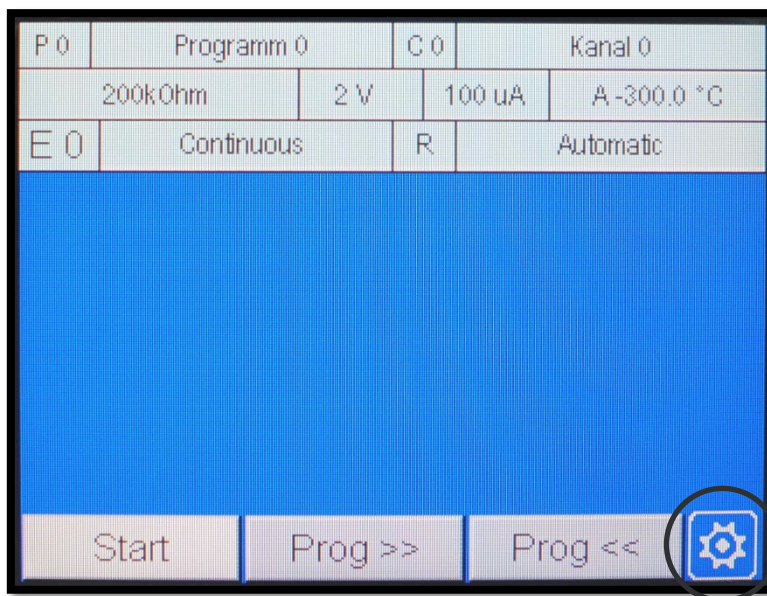

2. Go to "Basic setup menu"

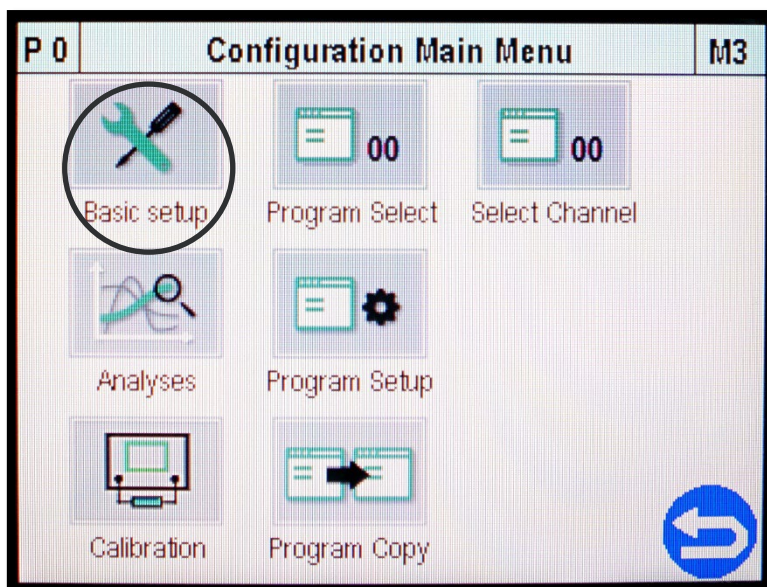

3. Scroll down to "PROFINET" menu:

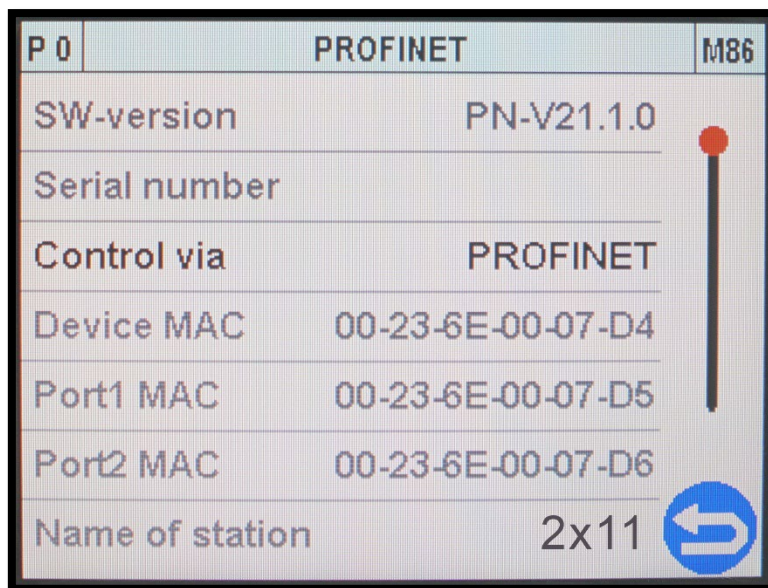
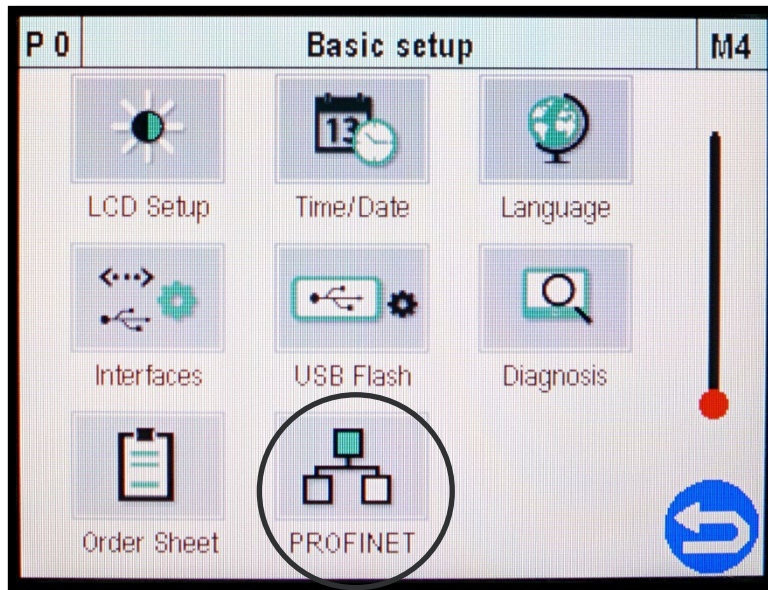

Parameters

Control via	<p>PROFINET: 2x11 responds solely to control signals (inputs) on the PROFINET interface</p> <p>PLC: 2x11 responds solely to control signals (inputs) on the PLC I/O interface.</p> <p>When controlled via PLC I/O, data from device is still transferred in the cyclical PROFINET protocol</p>
SW-Version of Interface	Version of the field bus card software
Serial number of interface	The serial number of the field bus card
Device MAC-address	Address to identify the field bus card inside of Profinet Network
Port1 MAC-address	Identification address of Profinet-Port 1 on the field bus card
Port2 MAC-address	Identification address of Profinet-Port 2 on the field bus card
Name of station	Name assigned to the field bus card
IP-address	IP-Address assigned by the Controller or a Configuration tool
Subnet mask	Subnet mask assigned by the Controller or a Configuration tool
Gateway	Gateway assigned by the Controller or a Configuration tool

5 PROFINET

5.1 General information on PROFINET data transfer

For PROFINET (cyclic data traffic), one must define at the configuration stage how many bytes are transferred between Controller and Device during each cyclic access (GSDML file).

The device is controlled using the data transferred from Controller to Device. This data always consists of four bytes for the RESISTOMAT® 2x11 unit. The function of these four bytes is explained in section 6.1.

The 2x11 cyclically sends 4 bytes to controller. Their function is detailed in section 6.2.

5.2 GSDML file

Resistomat equipment with the PROFINET option is supplied with a CD. This disk includes the device description file *GSDML-V2.35-BURSTER-RESISTOMAT-2311-20211019* (GSDML file). This GSDML file describes the physical properties of the device.

The structure, contents and encoding of this device description data is standardized so that any Profinet devices can be configured using configuration tools from various manufacturers.

The GSDML file does not specify what data is transferred or how this data should be interpreted. The user must glean this information from the operating manual and program his Controller accordingly.

5.3 Data conversion

5.3.1 Description of the data formats in this manual

The terms PLC inputs and PLC outputs refer to the 2x11 unit. These terms are reversed when referred to the Controller.

The function of the PLC-In / PLC-Out bits is identical to the parallel PLC I/O ports on the unit itself and can be found in the RESISTOMAT® 2x11 operating manual.

The floating-point numbers ("float") mentioned are four bytes long (32 bits) and are based on the IEEE-754 standard.

Numbers that are not specifically labeled or are labeled with "d" or "dec" are decimal numbers, i.e. 1234, 1234dec, dec1234, 1234d.

Numbers labeled "0x" or "hex" are hexadecimal numbers, i.e. 0x1234, hex1234, 1234hex, 1234h.

Numbers labeled "b" or "bin" are binary numbers, i.e. b1100, bin1100, 1100b, 1100bin.

5.3.2 Handling problems that arise when reading floating-point numbers

This only concerns cases in which floating-point numbers need to be read from the 2x11 unit.

Floating-point numbers (data type REAL), according to IEEE 754, are encoded as four bytes for transfer. This may create problems depending on the type of PLC used.

Cause

In the Resistomat 2x11 -PROFINET, the sign byte is transferred first if using acyclic data transfer and last during cyclic data transmission. Some PLCs expect this byte in the highest of the four addresses not in the lowest address. This inevitably leads to misinterpretation of the numeric value. In this case, the order of the four bytes has to be changed by the PLC as shown in the figure.

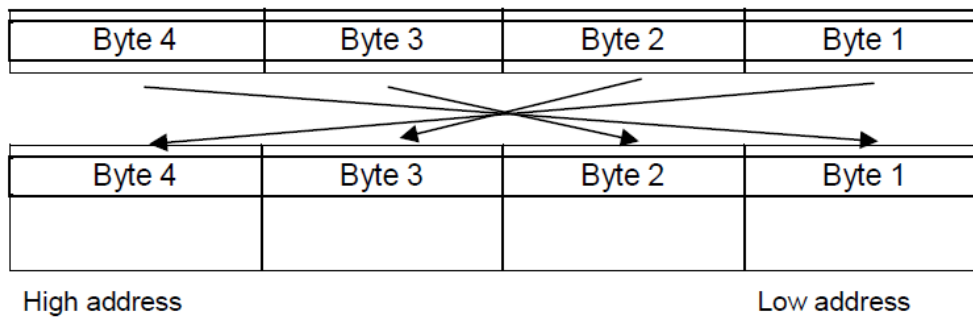

Diagram 3: Exchange of the order of bytes caused by misinterpretation of the numeric value

6 PROFINET data protocol

6.1 PLC inputs – Transfer from controller to device

Four bytes of PLC-In data for the 2x11 are always transferred from the PROFINET Controller to the RESISTOMAT® 2x11. These bits have the same function as the parallel PLC inputs to the 2x11 unit.

(See detailed documentation of these signals within the 2x11 operation manual, section 7.1.3 Program Selection/Renaming & comparator statistics reset (Slot 32))

Note: Bits marked as 'reserved' should remain at 0.

6.1.1 PLC inputs byte 1

PLC inputs Byte 1 (Controller -> Device)	
Start/Stop measurement	Bit 0 LSB
Start/Stop comparator	Bit 1
Start/Stop max/min recording	Bit 2
Start/Stop datalogger	Bit 3
Start/Stop AUTO mode	Bit 4
Clear error bit	Bit 5
Reset comparator statistic	Bit 6
End load cooling curve	Bit 7 MSB

6.1.2 PLC inputs byte 2

PLC inputs Byte 2 (Controller -> Device)	
Program number - bit 0	Bit 0 LSB
Program number - bit 1	Bit 1
Program number - bit 2	Bit 2
Program number - bit 3	Bit 3
Program number - bit 4	Bit 4
reserved	Bit 5
reserved	Bit 6
Program number - strobe	Bit 7 MSB

6.1.3 PLC inputs byte 3

PLC inputs Byte 3 (Controller -> Device)	
Channel number - bit 0	Bit 0 LSB
Channel number - bit 1	Bit 1
Channel number - bit 2	Bit 2
Channel number - strobe	Bit 3
Input AUX0 (reserved)	Bit 4
Input AUX1 (reserved)	Bit 5
Input AUX2 (reserved)	Bit 6
Input AUX3 (reserved)	Bit 7 MSB

6.1.4 PLC inputs byte 4

PLC inputs Byte 4 (Controller -> Device)	
reserved	Bit 0 LSB
reserved	Bit 1
reserved	Bit 2
reserved	Bit 3
reserved	Bit 4
reserved	Bit 5
reserved	Bit 6
reserved	Bit 7 MSB

6.2 PLC outputs – Transfer from device to controller

The data refers to the PLC output of the RESISTOMAT® 2x11. The data described here is the data transferred from the 2x11 to the PROFINET controller.

The function of the PLC-In / PLC-Out can be found in the 2x11 operation manual for the unit.

6.2.1 PLC outputs byte 1

PLC outputs Byte 1 (Device -> Controller)	
Ready	Bit 0 LSB
Measurement running	Bit 1
Measurement result - OK	Bit 2
Measurement result - NOK	Bit 3
Error	Bit 4
reserved	Bit 5
reserved	Bit 6
reserved	Bit 7 MSB

6.2.2 PLC outputs byte 2

PLC outputs Byte 2 (Device -> Controller)	
Current program number - bit 0	Bit 0 LSB
Current program number - bit 1	Bit 1
Current program number - bit 2	Bit 2
Current program number - bit 3	Bit 3
Current program number - bit 4	Bit 4
reserved	Bit 5
reserved	Bit 6
Current program number - strobe	Bit 7 MSB

6.2.3 PLC outputs byte 3

PLC outputs Byte 3 (Device -> Controller)	
Current channel number - bit 0	Bit 0 LSB
Current channel number - bit 1	Bit 1
Current channel number - bit 2	Bit 2
Current channel number - strobe	Bit 3
Output AUX0 (reserved)	Bit 4
Output AUX1 (reserved)	Bit 5
Output AUX2 (reserved)	Bit 6
Output AUX3 (reserved)	Bit 7 MSB

6.2.4 PLC outputs byte 4

PLC outputs Byte 4 (Device -> Controller)	
Comparator >>	Bit 0 LSB
Comparator >	Bit 1
Comparator =	Bit 2
Comparator <	Bit 3
Comparator <<	Bit 4
reserved	Bit 5
reserved	Bit 6
reserved	Bit 7 MSB

7 Acyclic PROFINET services

The services are described from the point of view of the controller.

Please Note: The subslot number always has to be set to 1.

The acyclic PROFINET services allow access to the following RESISTOMAT® 2x11 functions:

- Complete device configuration
- Transfer of component/worker/job data for logging
- Retrieval of measurement values and related analytical data

For further information and support for Siemens PLC integration, please contact our service department at service@burster.com.

7.1 Instrument configuration

7.1.1 General settings (Slot 30)

Slot 30, Indices 0 to 77

Slot	Index	Description	Value	Meaning of value	Type	Le n	R/ W
30	0		-	Not possible	x	x	x
30	1 - 9	Reserved	-	Not possible	x	x	x
30	10	Device identifier	RESISTOMAT® 2311		STR15	15	RO
30	11	Serial number	1234567890A		STR11	11	RO
30	12	Software version	V202100		STR15	15	RO
30	13	Bootloader software version	V202100		STR15	15	RO
30	14	Field bus interface software version	PN-V202110		STR15	15	RO
30	15	Type (1 or 8 Channel)	0 1	One channel Eight Channels	U16	2	RO
30	16	Station name	Stat14 right	Device station name	STR15	15	RW
30	17	Calibration date analog interface	28.01.2021		STR10	10	RO
30	18	Language	0 1 2 3 4	German English French Spanish Italian	U16	2	RW
30	19	Date	[dd.mm.yyyy]	e.g.: 21.01.2021	STR10	10	RW
30	20	Time	[hh:mm:ss], 24h	e.g.: 16:15:00	STR8	8	RW
30	21	LCD brightness	1 ... 10	Integer value (10 max.)	U16	2	RW
30	22	Measurement menu function key definition F1	0 1 2 3	Off Start/Stop Meas. program + Meas. program -	U16	2	RW

			4 5 6 7 8	Channel + Channel - End Load Range + Range -			
30	23	Measurement menu function key definition F2	0 1 2 3 4 5 6 7 8	Off Start/Stop Meas. program + Meas. program - Channel + Channel - End Load Range + Range -	U16	2	RW
30	24	Measurement menu function key definition F3	0 1 2 3 4 5 6 7 8	Off Start/Stop Meas. program + Meas. program - Channel + Channel - End Load Range + Range -	U16	2	RW
30	25	Display mode of function Keys	0 1	Fade out Always on	U16	2	RW
30	26	Type of measured value display	0 1 2	Ohm d% evaluation	U16	2	RW
30	27	Access authorization Password protection on/off Note: If the user password is entered, indices 28- 47 control device access. Using the master password bypasses this.	0 1	Password protection off Password protection on	U16	2	RW
30	28	Access level: Basic setup	0 1	Access DENIED Access GRANTED	U16	2	RW
30	29	Access level: Program selection	0 1	Access DENIED Access GRANTED	U16	2	RW
30	30	Access level: Program copy	0 1	Access DENIED Access GRANTED	U16	2	RW
30	31	Access level: Measurement mode	0 1	Access DENIED Access GRANTED	U16	2	RW
30	32	Access level: Test operation	0 1	Access DENIED Access GRANTED	U16	2	RW
30	33	Access level: External memory	0 1	Access DENIED Access GRANTED	U16	2	RW
30	34	Access level: Comparator	0 1	Access DENIED Access GRANTED	U16	2	RW
30	35	Access level: Max / Min	0 1	Access DENIED Access GRANTED	U16	2	RW
30	36	Access level: Data Logger	0 1	Access DENIED Access GRANTED	U16	2	RW

30	37	Access level: Temp. Compensation	0 1	Access DENIED Access GRANTED	U16	2	RW
30	38	Access level: Pt100	0 1	Access DENIED Access GRANTED	U16	2	RW
30	39	Access level: Volt. Input	0 1	Access DENIED Access GRANTED	U16	2	RW
30	40	Access level: Disp. Meas.	0 1	Access DENIED Access GRANTED	U16	2	RW
30	41	Access level: Select Channel	0 1	Access DENIED Access GRANTED	U16	2	RW
30	42	Access level: Assign Channel	0 1	Access DENIED Access GRANTED	U16	2	RW
30	43	Access level: Max / Min Analysis	0 1	Access DENIED Access GRANTED	U16	2	RW
30	44	Access level: Comparator Analysis	0 1	Access DENIED Access GRANTED	U16	2	RW
30	45	Access level: Data Logger Analysis	0 1	Access DENIED Access GRANTED	U16	2	RW
30	46	Access level: Cooling Curve	0 1	Access DENIED Access GRANTED	U16	2	RW
30	47	Access level: Calibration	0 1	Access DENIED Access GRANTED	U16	2	RW
30	48	Master password Note: The password is always 4 digits long, if less are supplied they are padded with 0s from the left	0000 ... 9999	4 digit master password	U16	2	RW
30	49	Reset Master password	<i>EVENT!</i>	Writing an arbitrary byte initiates action	U8	1	WO
30	50	User password Note: Same conditions as with attribute 48	0000 ... 9999	4 digit user password	U16	2	RW

Slot 30, Index 51 (Assignment adjustable PLC output 1)

Slot	Index	Description	Value	Meaning of value	Type	Len	R/W
30	51	adj. PLC output 1	0 1 2 3 4 5 6 7 8 9 10 11 12 13 14	OUT_READY OUT_OK OUT_NOK OUT_STROBE OUT_PROG0 OUT_PROG1 OUT_PROG2 OUT_PROG3 OUT_MEAS_ACT OUT_ERROR OUT_COMP_>> OUT_COMP_> OUT_COMP_= OUT_COMP_< OUT_COMP_<<	U16	2	RW

Slot	Index	Description	Value	Meaning of value	Type	Len	R/W
			15	OUT_CHAN_STROBE			
			16	OUT_CHAN0			
			17	OUT_CHAN1			
			18	OUT_CHAN2			
			19	OUT_AUX0			
			20	OUT_AUX1			
			21	OUT_AUX2			
			22	OUT_AUX3			

Slot 30, Indices 52 to 61 (Assignment adjustable PLC outputs 2 to 11)

Slot	Index	Description	Value	Meaning of value	Type	Len	R/W
30	52	adj. PLC output 2	<i>see index 31</i>		U16	2	RW
30	53	adj. PLC output 3	<i>see index 31</i>		U16	2	RW
30	54	adj. PLC output 4	<i>see index 31</i>		U16	2	RW
30	55	adj. PLC output 5	<i>see index 31</i>		U16	2	RW
30	56	adj. PLC output 6	<i>see index 31</i>		U16	2	RW
30	57	adj. PLC output 7	<i>see index 31</i>		U16	2	RW
30	58	adj. PLC output 8	<i>see index 31</i>		U16	2	RW
30	59	adj. PLC output 9	<i>see index 31</i>		U16	2	RW
30	60	adj. PLC output 10	<i>see index 31</i>		U16	2	RW
30	61	adj. PLC output 11	<i>see index 31</i>		U16	2	RW
30	62	adj. PLC output 12	<i>see index 31</i>		U16	2	RW

Slot 30, Index 63 (Assignment adjustable PLC input 1)

Slot	Index	Description	Value	Meaning of value	Type	Len	R/W
30	63	adj. PLC input 1	0	SPS_IN_WHL_AUTO	U16	2	RW
			1	SPS_IN_WHL_RESET_STAT			
			2	SPS_IN_WHL_STROBE			
			3	SPS_IN_WHL_ACK_ERROR			
			4	SPS_IN_WHL_CHAN_STROBE			
			5	SPS_IN_WHL_COMP_START			
			6	SPS_IN_WHL_MAX_MIN_START			
			7	SPS_IN_WHL_LOGGER_START			
			8	SPS_IN_WHL_END_LOAD			
			9	SPS_IN_WHL_AUX0			
			10	SPS_IN_WHL_AUX1			
			11	SPS_IN_WHL_AUX2			
			12	SPS_IN_WHL_AUX3			
			13	SPS_IN_WHL_CHAN_I0			
			14	SPS_IN_WHL_CHAN_I1			
			15	SPS_IN_WHL_CHAN_I2			
			16	SPS_IN_WHL_I0			

Slot	Index	Description	Value	Meaning of value	Type	Len	R/W
			17	SPS_IN_WHL_I1			
			18	SPS_IN_WHL_I2			
			19	SPS_IN_WHL_I3			

Slot 30, Indices 64 to 70 (Assignment adjustable PLC inputs 2 to 9)

Slot	Index	Description	Value	Meaning of value	Type	Len	R/W
30	64	adj. PLC input 2	<i>see index 42</i>		U16	2	RW
30	65	adj. PLC input 3	<i>see index 42</i>		U16	2	RW
30	66	adj. PLC input 4	<i>see index 42</i>		U16	2	RW
30	67	adj. PLC input 5	<i>see index 42</i>		U16	2	RW
30	68	adj. PLC input 6	<i>see index 42</i>		U16	2	RW
30	69	adj. PLC input 7	<i>see index 42</i>		U16	2	RW
30	70	adj. PLC input 8	<i>see index 42</i>		U16	2	RW
30	71	adj. PLC input 9	<i>see index 42</i>		U16	2	RW

Slot 30, Indices 72 to 78

Slot	Index	Description	Value	Meaning of value	Type	Len	R/W
30	72	Order sheet: Operator	<i>Michael_Mueller</i>		STR 64	64	RW
30	73	Order sheet: Order number	<i>AN_123456</i>		STR 64	64	RW
30	74	Order sheet: Batch	<i>BATCH_257-3</i>		STR 64	64	RW
30	75	Order sheet: Component	<i>Cylinder_right</i>		STR 64	64	RW
30	76	Order sheet: Serial number 1	<i>SN_12345678 9</i>		STR 64	64	RW
30	77	Order sheet: Serial number 2	<i>SN_98765432 1</i>		STR 64	64	RW
30	78	Update display (refresh view)	<i>Event!</i>	Writing an arbitrary byte initiates action	U8	1	WO

7.1.2 Display update and fault indication (Slot 31)

Slot	Index	Description	Value	Meaning of value	Type	Len	R/W
31	0	Not possible	-	-	x	x	x
31	1 - 9	Reserved	-	-	x	x	x
31	10	Initiate update of the LCD display	<i>EVENT!</i>	Writing an arbitrary byte initiates action	U8	1	WO

Slot	Index	Description	Value	Meaning of value	Type	Len	R/W
31	11	Device fault status	0x00000000	No fault	U32	4	RO
			0x00000001	PREFIX addressing fault			
			0x00000002	Enquiry received in Device mode			
			0x00000004	Block check error			
			0x00000008	Command fault			
			0x00000010	Parameter error			
			0x00000020	Timeout Receive Timer			
			0x00000040	Timeout Response Timer			
			0x00000080	Invalid ! or ?			
			0x00000100	Invalid configuration			
			0x00001000	EEPROM read error			
			0x00010000	Calibration failed			
			0x00040000	NETX Checksum error			
			0x20000000	USB flash error			

7.1.3 Program Selection/Renaming & comparator statistics reset (Slot 32)

Slot	Index	Description	Value	Meaning of value	Type	Len	R/W
32	0	Not possible	-	-	x	x	x
32	1 - 9	Reserved	-	-	x	x	x
32	10	Current program number Note: The value from index 10 is applied through index 12, 13 or 14	0 ... 31		U16	2	RW
32	11	Current program name Note: The value from index 11 is applied through index 12	<i>Program name</i>		STR 20	20	RW
32	12	Apply program name for selected program Note: Apply program name from index 11 for program in index 10	<i>EVENT!</i>		U8	1	WO
32	13	Apply measurement program selection Note: Value entered into index 10 is adopted	<i>EVENT!</i>		U8	1	WO
32	14	Reset comparator statistics of selected measurement program	<i>EVENT!</i>		U8	1	WO

Slot	Index	Description	Value	Meaning of value	Type	Len	R/W
		Note: Value entered into index 10 is adopted					

7.1.4 Channel assignment (Slot 33)

Slot	Index	Description	Value	Meaning of value	Type	Len	R/W
33	0	Not possible	-	-	x	x	x
33	1 - 9	Reserved	-	-	x	x	x
33	10	Assign channel 0 to program number	0 ... 31		U16	2	RW
33	11	Assign channel 1 to program number	see index 10		U16	2	RW
33	12	Assign channel 2 to program number	see index 10		U16	2	RW
33	13	Assign channel 3 to program number	see index 10		U16	2	RW
33	14	Assign channel 4 to program number	see index 10		U16	2	RW
33	15	Assign channel 5 to program number	see index 10		U16	2	RW
33	16	Assign channel 6 to program number	see index 10		U16	2	RW
33	17	Assign channel 7 to program number	see index 10		U16	2	RW

7.1.5 Measurement mode (Slot 38)

Slot	Index	Description	Value	Meaning of value	Type	Len	R/W
38	0	Not possible	-	-	x	x	x
38	1 - 9	Reserved	-	-	x	x	x
38	10	Range selection	0 1	manual automatic	U16	2	RW
38	11	Measurement range in manual range mode	1 2 3 4 5 6 7 8	20 mOhm 200 mOhm 2 Ohm 20 Ohm 200 Ohm 2 kOhm 20 kOhm 200 kOhm	U16	2	RW
38	12	Minimum range in automatic range mode Note: The settings	1 2 3 4 5	20 mOhm 200 mOhm 2 Ohm 20 Ohm 200 Ohm	U16	2	RW

Slot	Index	Description	Value	Meaning of value	Type	Len	R/W
		from indices 12 - 13 are applied through index 14	6 7	2 kOhm 20 kOhm			
38	13	Maximum range in automatic range mode Note: The settings from indices 12 - 13 are applied through index 14	2 3 4 5 6 7 8	200 mOhm 2 Ohm 20 Ohm 200 Ohm 2 kOhm 20 kOhm 200 kOhm	U16	2	RW
38	14	Set range for automatic range mode Note: Values entered into indices 12 and 13 are adopted	<i>EVENT</i>	Writing an arbitrary byte initiates action	U8	1	WO
38	15	Resistance type R/Z	0 1	R Z	U16	2	RW
38	16	Grounding on/off	0 1	Off On	U16	2	RW
38	17	Measuring Type	0 1 2	Single Continuous N measurements	U16	2	RW
38	18	Cable break test	0 1 2	Off Once Always	U16	2	RW
38	19	Number of measurements until stop	1 ... 20		U16	2	RW
38	20	Number of mean values	1 ... 100		U16	2	RW
38	21	Type of averaging: renewing/moving	0 1	Renewing Moving	U16	2	RW
38	22	Voltage limiting	0 1 2	Off 18 mV 2V	U16	2	RW
38	23	Number of conversions	0 1 2 3	Standard Minimal Medium Maximum	U16	2	RW
38	24	Measuring Process	0 1 2 3 4	Standard Comp. once Without com. Ref comp. Current test	U16	2	RW
38	25	Measuring current: large/small	0 1	Large Small	U16	2	RW
38	26	Resolution 2000/20000 digits	0 1	2000 digits 20000 digits	U16	2	RW
38	27	Behavior in case of measuring error	0 1	stop measuring continue measuring	U16	2	RW

7.1.6 Copy/initialize measurement programs (Slot 39)

Slot	Index	Description	Value	Meaning of value	Type	Len	R/W
39	0	Not possible	-	-	x	x	x
39	1 - 9	Reserved	-	-	x	x	x
39	10	Meas. program number source Note: The settings from indices 10 - 12 are being adopted through indices 13 - 14	0 ... 31		U16	2	WO
39	11	Meas. program number Target start Note: The settings from indices 10 - 12 are being adopted through indices 13 - 14	0 ... 31		U16	2	WO
39	12	Meas. program number Target end Note: The settings from indices 10 - 12 are being adopted through indices 13 - 14	0 ... 31		U16	2	WO
39	13	Copy whole program setup Note: Copy according to entries in indices 10 - 12.	EVENT	Writing an arbitrary byte initiates action	U8	1	WO
39	14	Initialize selected programs Note: Initializing according to indices 11 - 12.	EVENT	Writing an arbitrary byte initiates action	U8	1	WO
39	15	Initialize all measurement programs and device parameters	EVENT	Writing an arbitrary byte initiates action	U8	1	WO

7.1.7 USB-Logging (Slot 40)

Slot	Index	Description	Value	Meaning of value	Type	Len	R/W
40	0	Not possible	-	-	x	x	x
40	1 - 9	Reserved	-	-	x	x	x

Slot	Index	Description	Value	Meaning of value	Type	Len	R/W
40	10	USB-Logging on/off	0 1	Off On	U16	2	RW
40	11	Logging of timestamp	0 1	Off On	U16	2	RW
40	12	Logging of numerator	0 1	Off On	U16	2	RW
40	13	Logging of order sheet	0 1	Off On	U16	2	RW
40	14	Delta t – Hours Note: The settings from indices 14 - 16 are being adopted through index 17	0 ... 99		U16	2	RW
40	15	Delta t – Minutes Note: The settings from indices 14 - 16 are being adopted through index 17	0 ... 59		U16	2	RW
40	16	Delta t – Seconds Note: The settings from indices 14 - 16 are being adopted through index 17	0 ... 59		U16	2	RW
40	17	Set Delta t Note: Values entered into indices 14, 15, 16 are adopted	<i>EVENT!</i>	Writing an arbitrary byte initiates action	U8	1	WO
40	18	Readings per header	1 ... 10000		U16	2	RW
40	19	State of USB-Drive	0 1 2 3	State couldn't be read Not attached Attached but not mounted Attached and mounted	U16	2	RO
40	20	Free space on USB-Drive	<i>String</i>	If USB Drive is not attached or not mounted (see index 12) "0,000 MB" will be returned	STR 15	15	RO
40	21	Format USB Drive	<i>String formatusb</i>	"formatusb" works as a password here	STR 9	9	WO
40	22	READY-Control	0 1	off on	U16	2	RW

7.1.8 Data-Logging (Slot 41)

Slot	Index	Description	Value	Meaning of value	Type	Len	R/W
41	0	Not possible	-	-	x	x	x
41	1 - 9	Reserved	-	-	x	x	x
41	10	Data logger on/off	0 1	Off On	U16	2	RW
41	11	Data logger filter	0	Record all values	U16	2	RW

Slot	Index	Description	Value	Meaning of value	Type	Len	R/W
			1 2 3 4 5	Record only OK values Record only NOK values Record every n. value Record if time > Delta t Record if value(i) – value(i-1) >= Delta R			
41	12	N. Value	2 ... 200		U16	2	RW
41	13	Delta t – Hours Note: The settings from indices 13 - 15 are being adopted through index 16	0 ... 99		U16	2	RW
41	14	Delta t – Minutes Note: The settings from indices 13 - 15 are being adopted through index 17	0 ... 59		U16	2	RW
41	15	Delta t – Seconds Note: The settings from indices 13 - 15 are being adopted through index 17	0 ... 59		U16	2	RW
41	16	Set Delta t Note: Values entered into indices 13, 14, 15 are adopted	<i>EVENT!</i>	Writing an arbitrary byte initiates action	U8	1	WO
41	17	Delta R (Filter Parameter)	0 ... 200000		U16	2	RW
41	18	Designation	<i>String</i>		STR 50	50	RW
41	19	Free data logger space			U16	2	RO
41	20	Number of stored values			U16	2	RO
41	21	Storage number of value to be read Note: the actual read is performed at index 22			U16	2	WO
41	22	Stored measurement values Note: the storage number has to be set at index 21 first	<i>String</i>	Format: dd.mm.yyyy, hh:mm:ss, delta in ms, state*, resistance *state (bit coded): Logical OR combined status: 0: No Error 1: Measurement range exceeded 2: Current overflow 4: Voltage overflow 8: Temperature compensation error 16: PT100 Measurement error 32: Cable break	STR 64	64	RO

Slot	Index	Description	Value	Meaning of value	Type	Len	R/W
				128: First Value after Start of Measurement			
41	23	Clear data logger	<i>EVENT!</i>	Writing an arbitrary byte initiates action	U8	1	WO

7.1.9 Comparator (Slot 42)

Slot	Index	Description	Value	Meaning of value	Type	Len	R/W
42	0	Not possible	-	-	x	x	x
42	1 - 9	Reserved	-	-	x	x	x
42	10	Comparator on/off	0 1	Off On	U16	2	RW
42	11	Number of limits	2 or 4		U16	2	RW
42	12	Behavior if error	0 1	Not used > or >>	U16	2	RW
42	13	Limit value << Note: The settings from indices 13 - 16 are being adopted through index 17		Float value Float according to IEEE754	FLT	4	RW
42	14	Limit value < Note: The settings from indices 13 - 16 are being adopted through index 17		Float value Float according to IEEE754	FLT	4	RW
42	15	Limit value > Note: The settings from indices 13 - 16 are being adopted through index 17		Float value Float according to IEEE754	FLT	4	RW
42	16	Limit value >> Note: The settings from indices 13 - 16 are being adopted through index 17		Float value Float according to IEEE754	FLT	4	RW
42	17	Set limits Note: Values entered into indices 13, 14, 15, 16 are adopted	<i>EVENT!</i>	Writing an arbitrary byte initiates action	U8	1	WO
42	18	Number of values < limit_<< If 2 limits: not relevant			U16	1	RO

Slot	Index	Description	Value	Meaning of value	Type	Len	R/W
42	19	Number of values > limit_<< and < limit_< If 2 limits: < Limit_<			U16	1	RO
42	20	Number of values > limit_< and < limit_> If 2 limits: > limit_< and < limit_>			U16	1	RO
42	21	Number of values > limit_> and < limit_>> If 2 limits: > limit_>			U16	1	RO
42	22	Number of values > limit_>> If 2 limits: not relevant			U16	1	RO
42	23	Total number of values			U16	1	RO
42	24	Reset statistic values	<i>EVENT!</i>	Writing an arbitrary byte initiates action	U8	1	WO

7.1.10 Max / Min Values (Slot 43)

Slot	Index	Description	Value	Meaning of value	Type	Len	R/W
43	0	Not possible	-	-	x	x	x
43	1 - 9	Reserved	-	-	x	x	x
43	10	Max / Min on/off	0 1	Off On	U16	2	RW
43	11	Minimum value		Float value Float according to IEEE754	FLT	4	RO
43	12	Maximum value		Float value Float according to IEEE754	FLT	4	RO
43	13	Maximum – Minimum value		Float value Float according to IEEE754	FLT	4	RO
43	14	Reset Max / Min values	<i>EVENT!</i>	Writing an arbitrary byte initiates action	U8	1	WO

7.1.11 PT100 (Slot 44)

Slot	Index	Description	Value	Meaning of value	Type	Len	R/W
44	0	Not possible	-	-	x	x	x
44	1 - 9	Reserved	-	-	x	x	x
44	10	Coefficient Ro of the Pt100 formula	90 ... 110	Float value Float according to IEEE754	FLT	4	RW
44	11	Coefficient A of Pt100 formula	3.0E-3 ... 6.0E-3	Float value Float according to IEEE754	FLT	4	RW

Slot	Index	Description	Value	Meaning of value	Type	Len	R/W
44	12	Coefficient B of Pt100 formula	-5.0E-6 ... 5.0E-6	Float value Float according to IEEEE754	FLT	4	RW
44	13	Resets the coefficients to their default values	EVENT!	Writing an arbitrary byte initiates action	U8	1	WO

7.1.12 Temperature compensation (Slot 45)

Slot	Index	Description	Value	Meaning of value	Type	Len	R/W
45	0	Not possible	-	-	x	x	x
45	1 - 9	Reserved	-	-	x	x	x
45	10	Temperature compensation On/Off	0 1	Off On	U16	2	RW
45	11	Detection of temperature	0 1 3	Manual Pt100 U Input	U16	2	RW
45	12	Manual temperature if manual temperature detection	-200 ... 999	Float value Float according to IEEEE754	FLT	4	RW
45	13	Reference temperature	-200 ... 999	Float value Float according to IEEEE754	FLT	4	RW
45	14	Temperature coefficient	0 1 2 3 4 5 6 7 8 9	1600 ppm/K 1700 ppm/K 2400 ppm/K 3100 ppm/K 3930 ppm/K 4030 ppm/K 4500 ppm/K 4800 ppm/K 6000 ppm/K 6500 ppm/K	U16	2	RW
45	15	User defined temperature coefficient	1000 ... 9999		U16	2	RW

7.1.13 Scaling of voltage input (Slot 46)

Slot	Index	Description	Value	Meaning of value	Type	Len	R/W
46	0	Not possible	-	-	x	x	x
46	1 - 9	Reserved	-	-	x	x	x
46	10	Lower voltage	0 ... 11	Float value Float according to IEEEE754	FLT	4	RW
46	11	Higher voltage	0 ... 11	Float value Float according to IEEEE754	FLT	4	RW
46	12	Lower temperature	-200 ... 800	Float value Float according to IEEEE754	FLT	4	RW
46	13	Higher temperature	-200 ... 800	Float value Float according to IEEEE754	FLT	4	RW

7.1.14 Cooling curve (Slot 47)

Slot	Index	Description	Value	Meaning of value	Type	Len	R/W
47	0	Not possible	-	-	x	x	x
47	1 - 9	Reserved	-	-	x	x	x
47	10	Cooling curve On/Off	0 1	Off On	U16	2	RW
47	11	Interval time	1 ... 100		U16	2	RW
47	12	Settling time	1 ... 100		U16	2	RW
47	13	Measuring end time	10 ... 100000		U16	2	RW
47	14	End load	EVENT!	Writing an arbitrary byte initiates action	U8	1	WO
47	15	Number of stored measurement value (starting with 0) Note: the actual read is performed at index 16	X...Y		U16	2	WO
47	16	Stored measurement value Note: the number of the measurement value to read has to be set at index 15 first	String	Format: <i>timestamp in seconds,state*,resistance with unit</i> <i>*state</i> (bit coded): 8 bit value Logical OR combined status: 0: No Error 1: Measurement range exceeded 2: Current overflow 4: Voltage overflow 8: Temperature compensation error 16: PT100 Measurement error 32: Cable break 128: First Value after Start of Measurement	STR64	64	RO

7.1.15 Current measurement values (Slot 48)

Slot	Index	Description	Value	Meaning of value	Type	Len	R/W
48	0	Not possible	-	-	x	x	x
48	1 - 9	Reserved	-	-	x	x	x
48	10	Measurement running state	0 1	Measurement is stopped Measurement is running	U16	2	RO
48	11	Measurement counter	0 ... 65536		U16	2	RO

Slot	Index	Description	Value	Meaning of value	Type	Len	R/W
48	12	Measurement status		Logical OR combined status: 0: No Error 1: Measurement range exceeded 2: Current overflow 4: Voltage overflow 8: Temperature compensation error 16: PT100 Measurement error 32: Cable break	U16	2	RO
48	13	Result of Evaluation	<i>String</i>		STR64	64	RO
48	14	Delta % of Set Point	<i>String</i>		STR64	64	RO
48	15	Resistance	<i>String</i>	Value plus appropriate Ohm unit	STR64	64	RO
48	16	Range	<i>String</i>	Value plus appropriate Ohm unit	STR64	64	RO
48	17	Current	<i>String</i>	Value plus unit	STR64	64	RO
48	18	Voltage	<i>String</i>	Value plus unit	STR64	64	RO
48	19	Temperature	<i>String</i>	Value in °C	STR64	64	RO

7.1.16 Record errors/events in the logfile (Slot 49)

Slot	Index	Description	Value	Meaning of value	Type	Len	R/W
49	0	Not possible	-	-	x	x	x
49	1 - 9	Reserved	-	-	x	x	x
49	10	Index of last entry	0 ... 255		U16	2	RO
49	11	Entry index Note: the actual read is performed at index 12	0 ... 255		U16	2	WO
49	12	Log entry Note: the index of the measurement value to read has to be set at index 11 first	String	Format: entry code*,program number,access**,year,month,day,hour,minute,second, repetitions *entry code: 0 -> no error 1 -> Memory error detected 4 -> Main analog board EEPROM error detected 39 -> Start of measurement without READY 40 -> Change of analog interface 42 -> Device power up 130 -> Menu: Measurement mode 136 -> Menu: Assignment PLC-Outputs 137 -> Menu: Assignment PLC-Inputs 139 -> Menu: Interface USB 140 -> Menu: Interface Ethernet 141 -> Copy Measurement setup 142 -> Initialize target program(s) 143 -> Copy whole setup 145 -> Menu: Comparator 146 -> Menu: Max / Min 147 -> Menu: Datalogger 148 -> Menu: Temp. Comp. 149 -> Menu: Pt100 150 -> Menu: Volt Input 151 -> Menu: Disp. Meas. 152 -> Menu: Assign Channel 153 -> Menu: Cooling Curve **access: 0 -> No access protection 1 -> Master access 2 -> User access 4 -> Access via port	STR64	64	RO

7.1.17 General Purpose (Slots 60-70)

Slot	Index	Description	Value	Meaning of value	Type	Len	R/W
60	0	Not possible	-	-	x	x	x
60	1 - 9	Reserved	-	-	x	x	x
60	10	Generic Value 1	<i>EVENT!</i>	Writing an arbitrary byte initiates action	U8	1	WO
60	11	Generic Value 2	<i>EVENT!</i>	Writing an arbitrary byte initiates action	U8	1	WO
60	12	Generic Value 3	<i>EVENT!</i>	Writing an arbitrary byte initiates action	U8	1	WO
60	13	Generic Value 4	<i>EVENT!</i>	Writing an arbitrary byte initiates action	U8	1	WO
60	14	Generic Value 5	<i>EVENT!</i>	Writing an arbitrary byte initiates action	U8	1	WO
60	15	Generic Value 6			U16	2	RW
60	16	Generic Value 7			U16	2	RW
60	17	Generic Value 8			U16	2	RW
60	18	Generic Value 9			U16	2	RW
60	19	Generic Value 10			U16	2	RW
60	20	Generic Value 11			U32	4	RW
60	21	Generic Value 12			U32	4	RW
60	22	Generic Value 13			U32	4	RW
60	23	Generic Value 14			U32	4	RW
60	24	Generic Value 15			U32	4	RW
60	25	Generic Value 16		Float value Float according to IEEE754	FLT	4	RW
60	26	Generic Value 17		Float value Float according to IEEE754	FLT	4	RW
60	27	Generic Value 18		Float value Float according to IEEE754	FLT	4	RW
60	28	Generic Value 19		Float value Float according to IEEE754	FLT	4	RW
60	29	Generic Value 20		Float value Float according to IEEE754	FLT	4	RW
60	30	Generic Value 21			STR64	64	RW
60	31	Generic Value 22			STR64	64	RW
60	32	Generic Value 23			STR64	64	RW
60	33	Generic Value 24			STR64	64	RW
60	34	Generic Value 25			STR64	64	RW

General Purpose (Slots 61-70)

See slot 60.

7.2 Error Codes

Error code	Description
0x00000000	PNIO_S_OK No error, write/read successful
0xDE80A000	READ_APPL_ERROR Data could not be read from the device.
0xDE80B000	READ_ACCESS_INVALIDINDEX This index is not specified
0xDE80B200	READ_ACCESS_INVALIDSLOT_SUBSLOT Reading from this slot is not supported Note: Only subslot 1 is supported
0xDE80B600	PNIO_E_IOD_READ_ACCESS_DENIED Read from this Slot/Subslot/Index not allowed
0xDE80C000	READ_RESOURCE_CONSTRAINCONFLICT The requested length is too small (< 2 Bytes)
0xDF80A100	WRITE_APPL_ERROR Data could not be written to the device. Please check your data and data length here.
0xDF80B000	WRITE_ACCESS_INVALIDINDEX This index is not specified
0xDF80B100	WRITE_ACCESS_INVALIDLENGTH Please check the length of the data which can be accepted by the DIGIFORCE 2x11
0xDF80B200	WRITE_ACCESS_INVALIDSLOT_SUBSLOT Reading from this slot/subslot is not supported Note: Only subslot 1 is supported
0xDF80B600	WRITE_ACCESS_DENIED Write to this Slot/Subslot/Index not allowed
0xDF80B800	WRITE_ACCESS_INVALIDPARAM Invalid parameter
0xDF80C100	WRITE_RESOURCE_CONSTRAINCONFLICT The length of the data to write is too small (< 2 Bytes)